

Werner Ahlgren

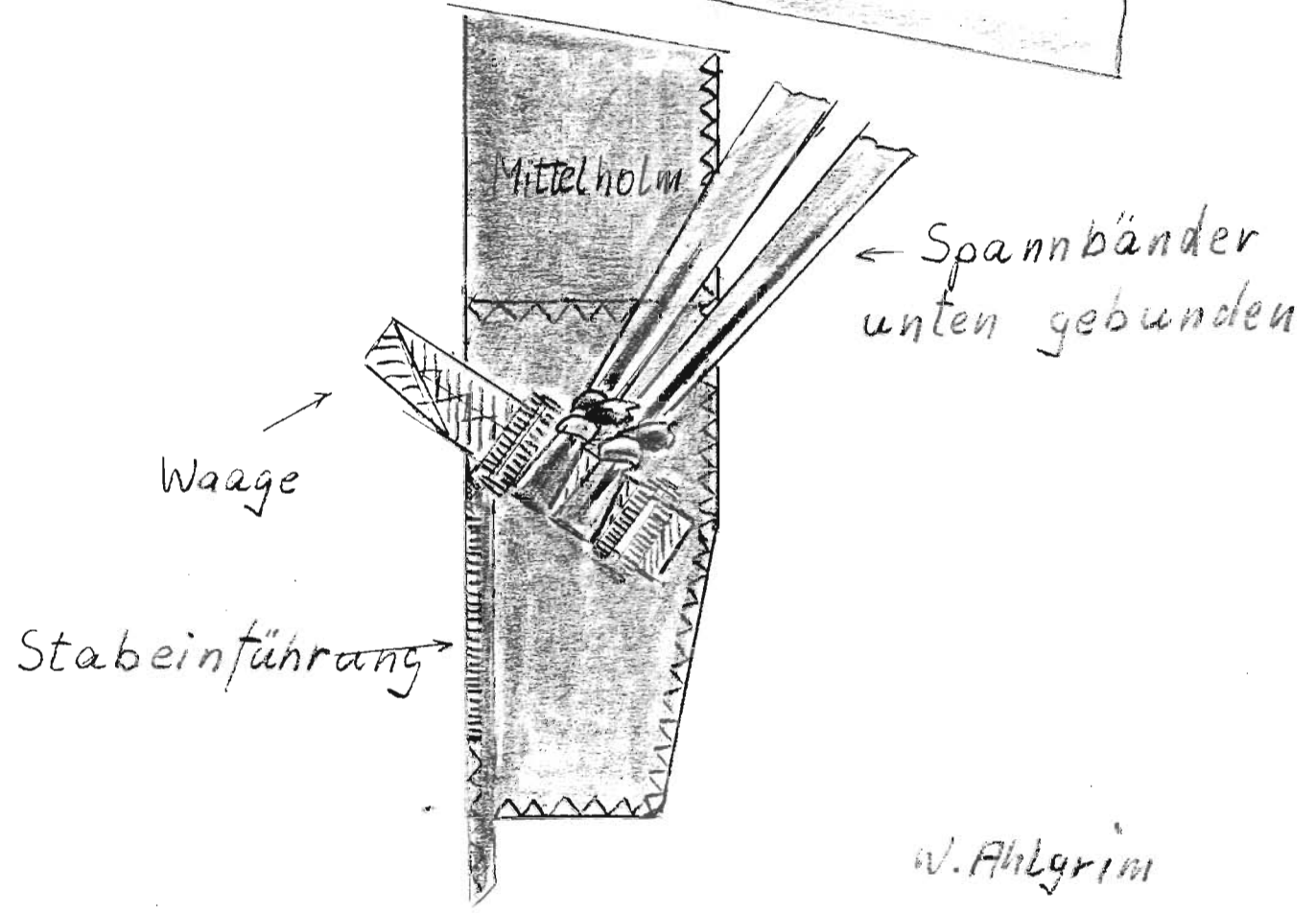

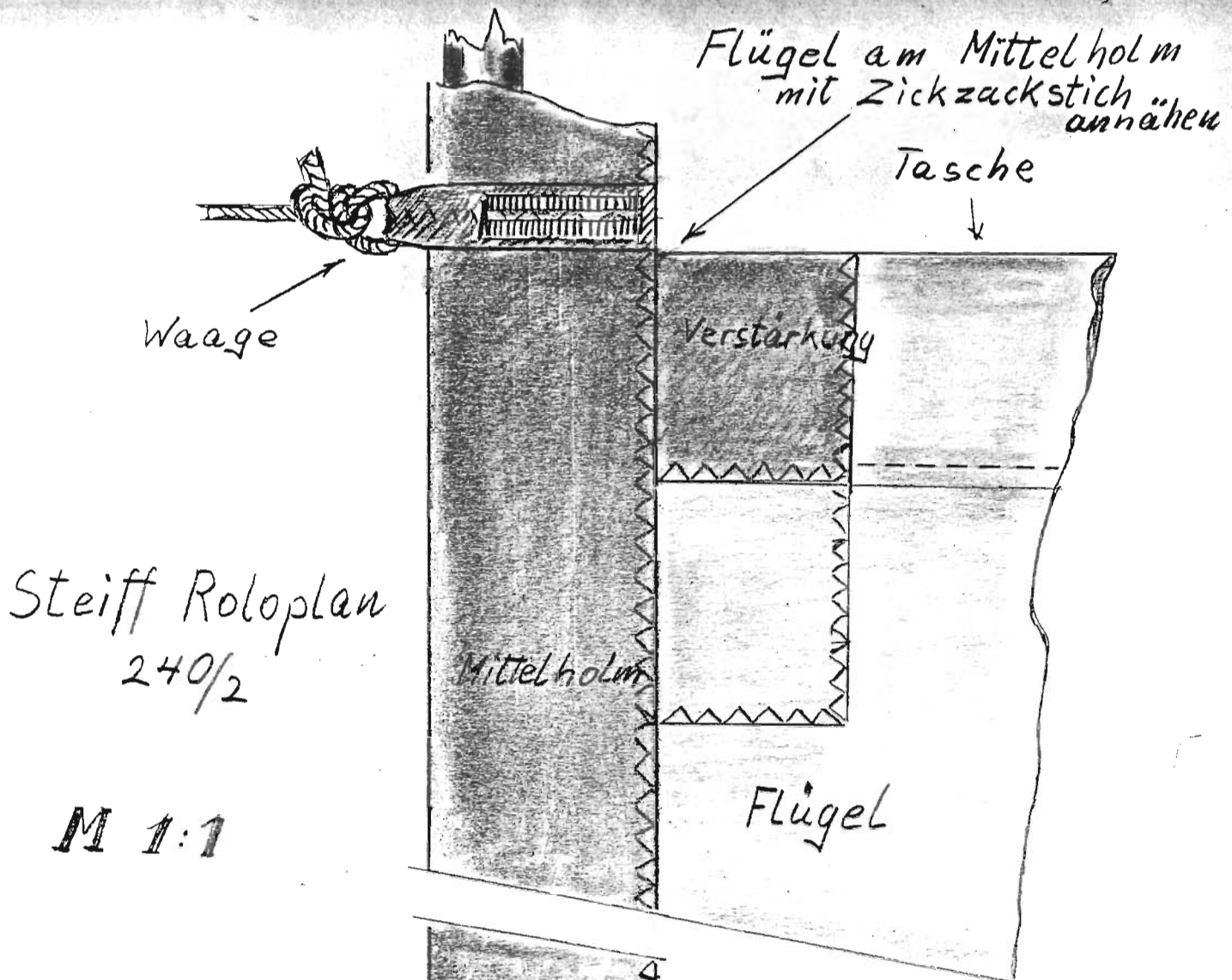
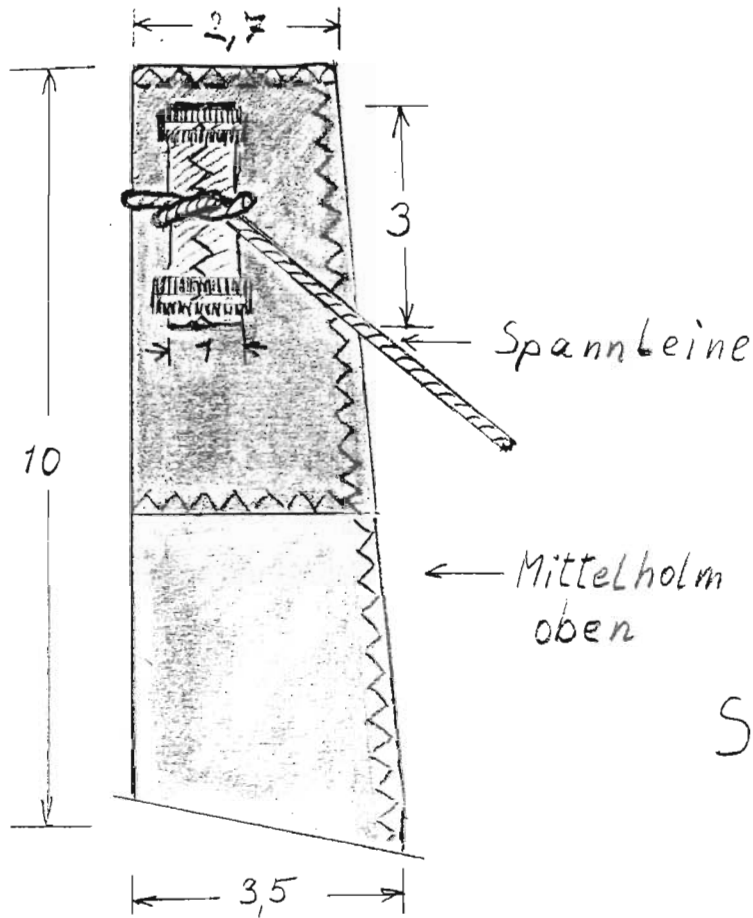

M 1:1

Steiff Rolplan
240/2

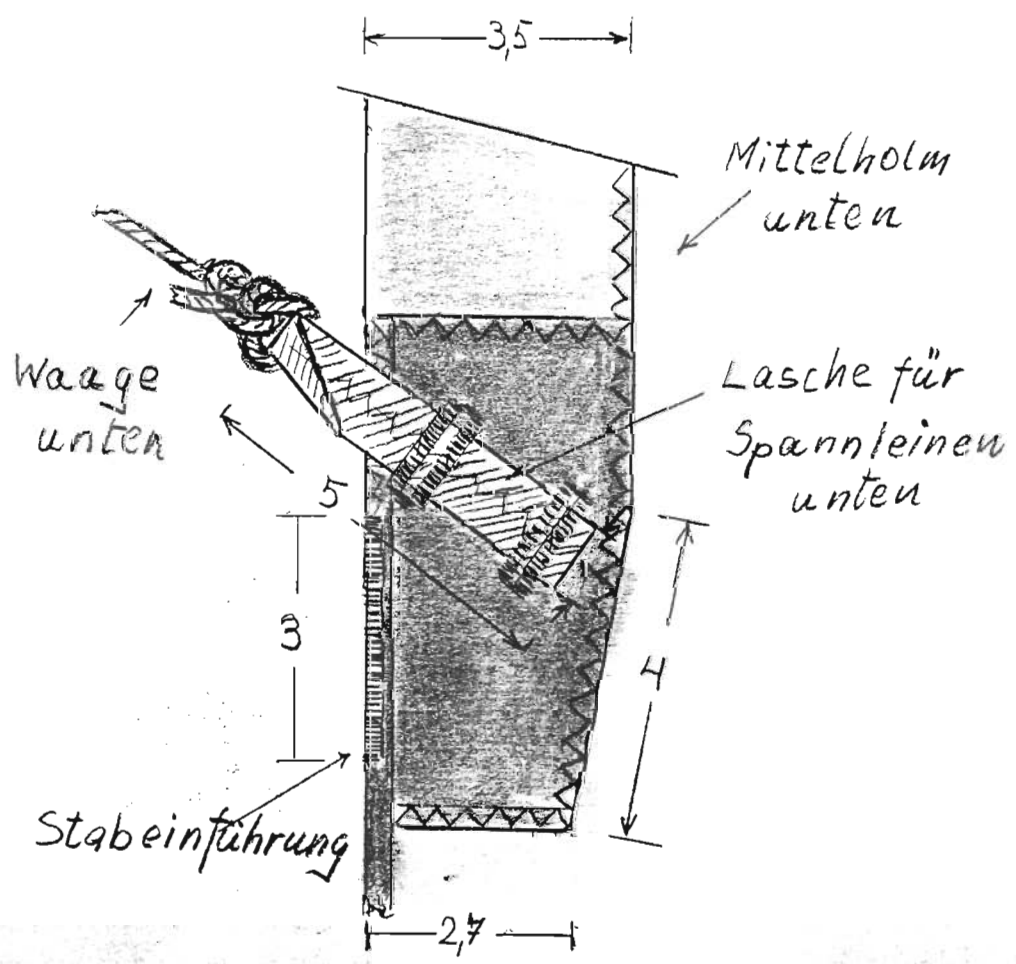

W Ahlgrim

Steiff Rolodlan 240/2

M 1:1

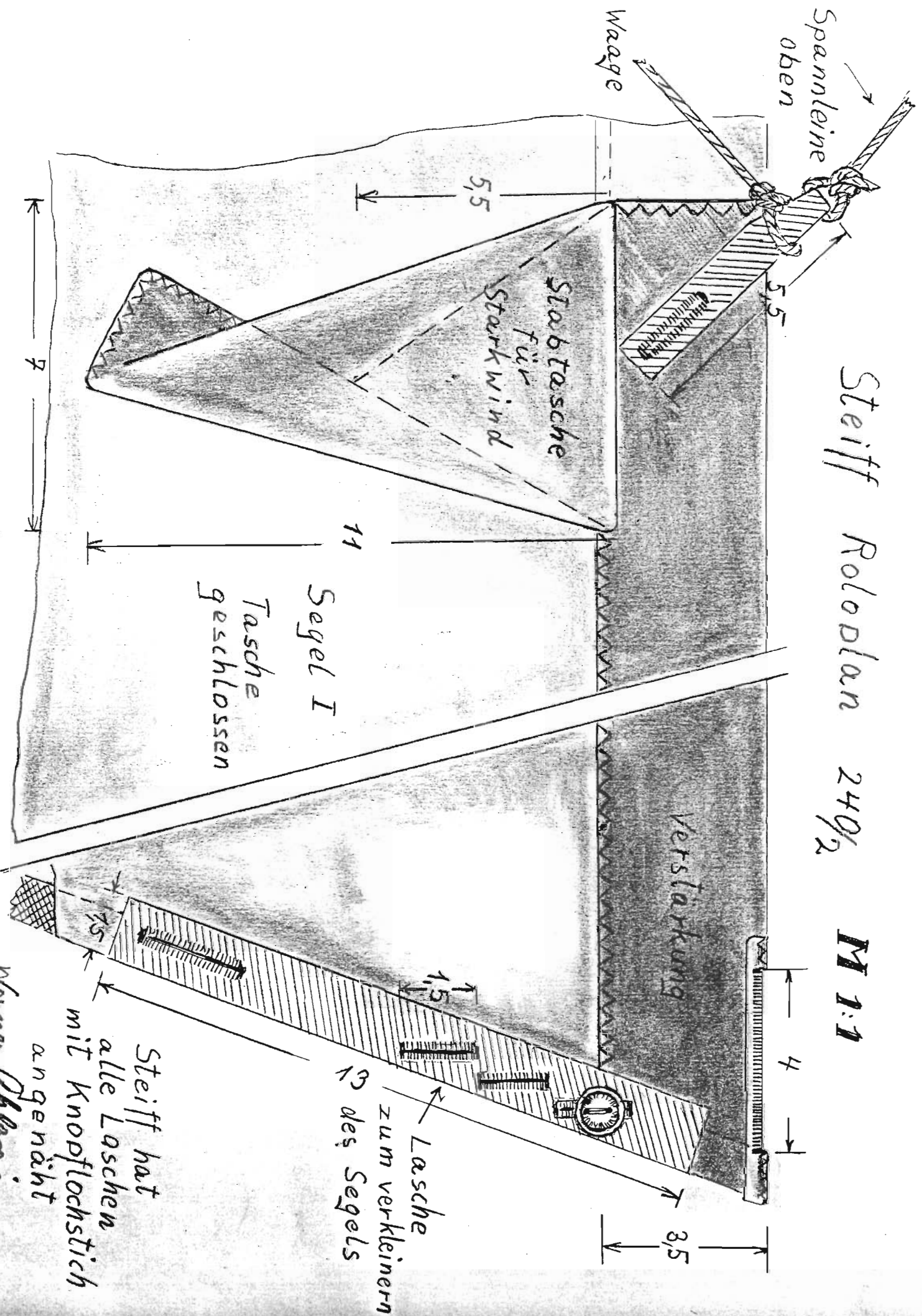

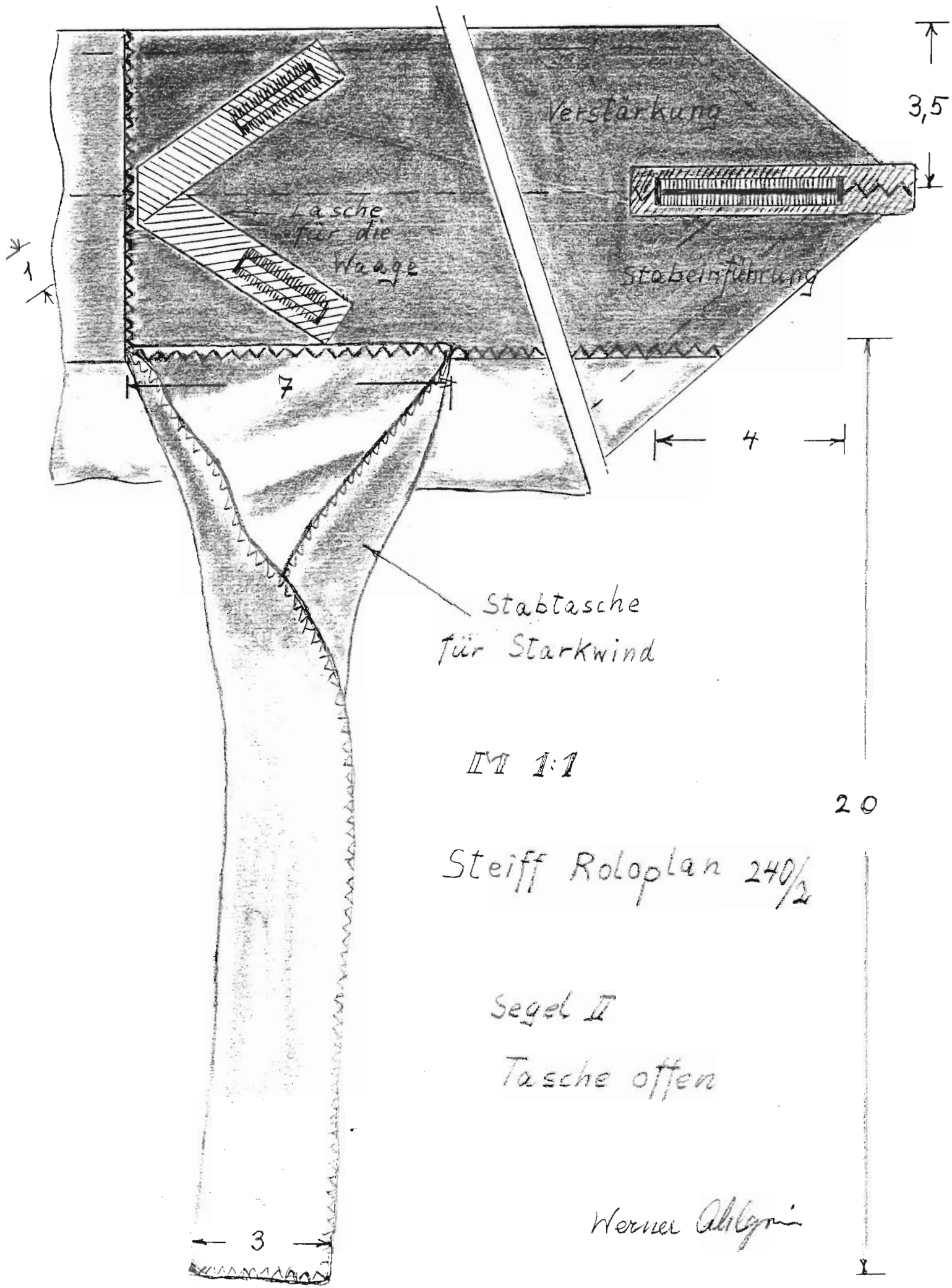

Verstärkung

↑
3,5

Lasche für die Waage

Stabeinführung

← 4 →

Stabtasche für Starkwind

20

1:1

Steiff Roloplan 240/2

Segel II

Tasche offen

← 3 →

Werner Abtgen

↓

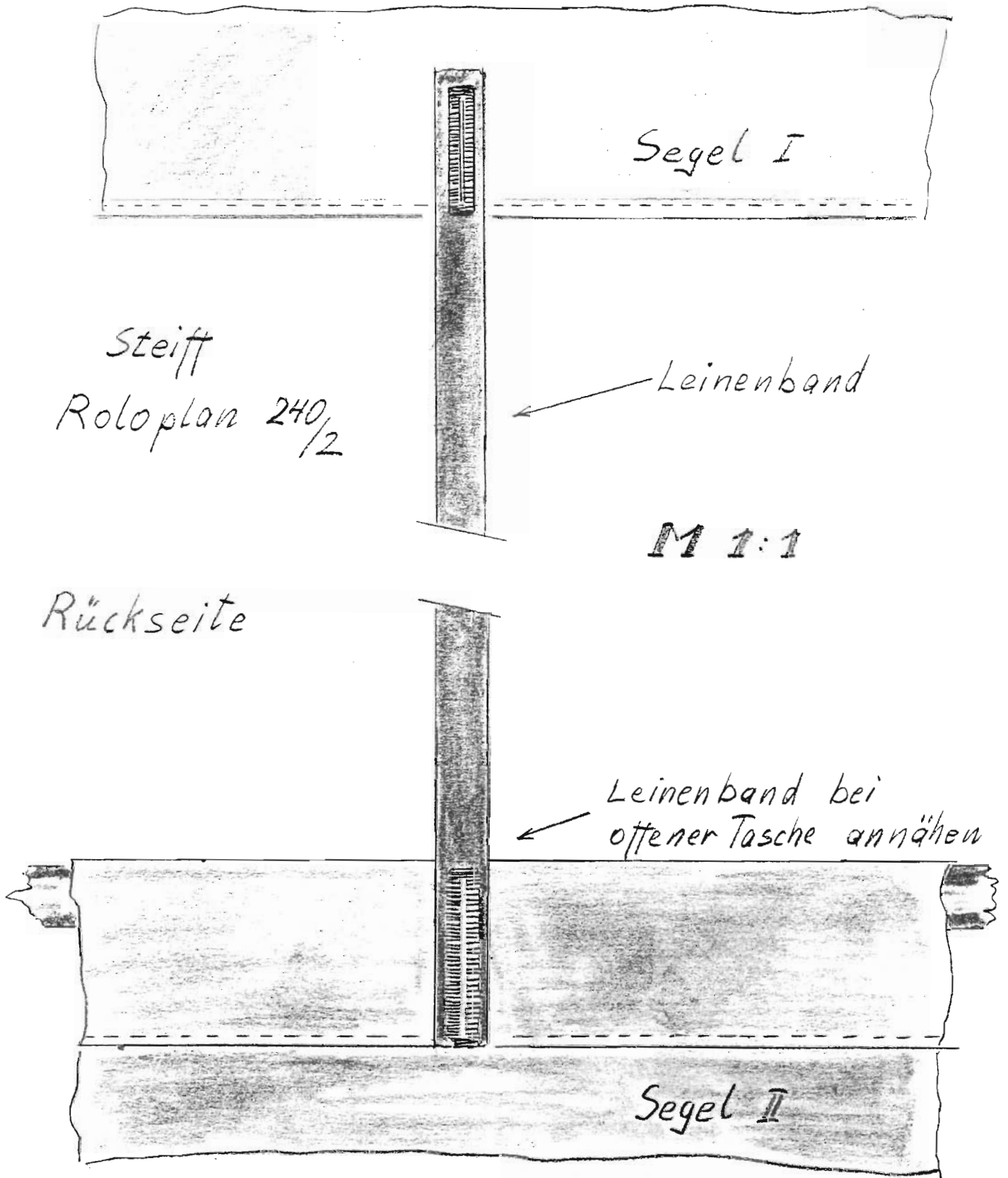

W. Ahlgrim